

Varenummer: 03445050
Beskrivelse: Fluro Heavy Duty Ledleje GE 50 EW-2RS
Hul Ø50
Note: 50

Mål

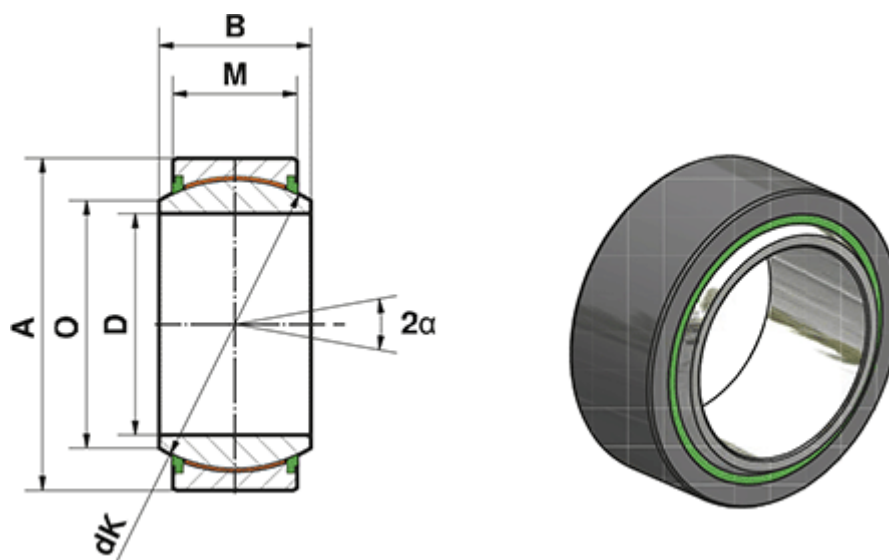

A	= 75	Statisk belastning C0 (kN) = 737
a (grader)	= 6	Vægt (g) = 530
B	= 35	
D	= 50	
dK	= 66	
Dynamisk belastning C (kN)	= 442	
M	= 28	
O	= 55.9	